

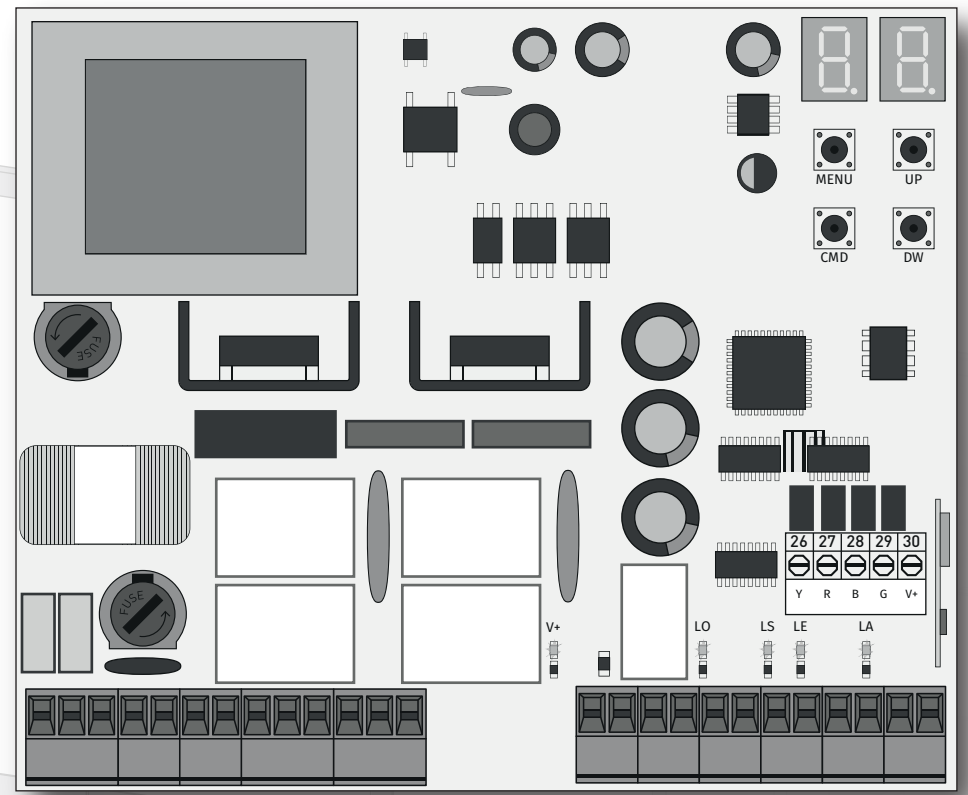

# MC52

## USER/INSTALLER MANUAL

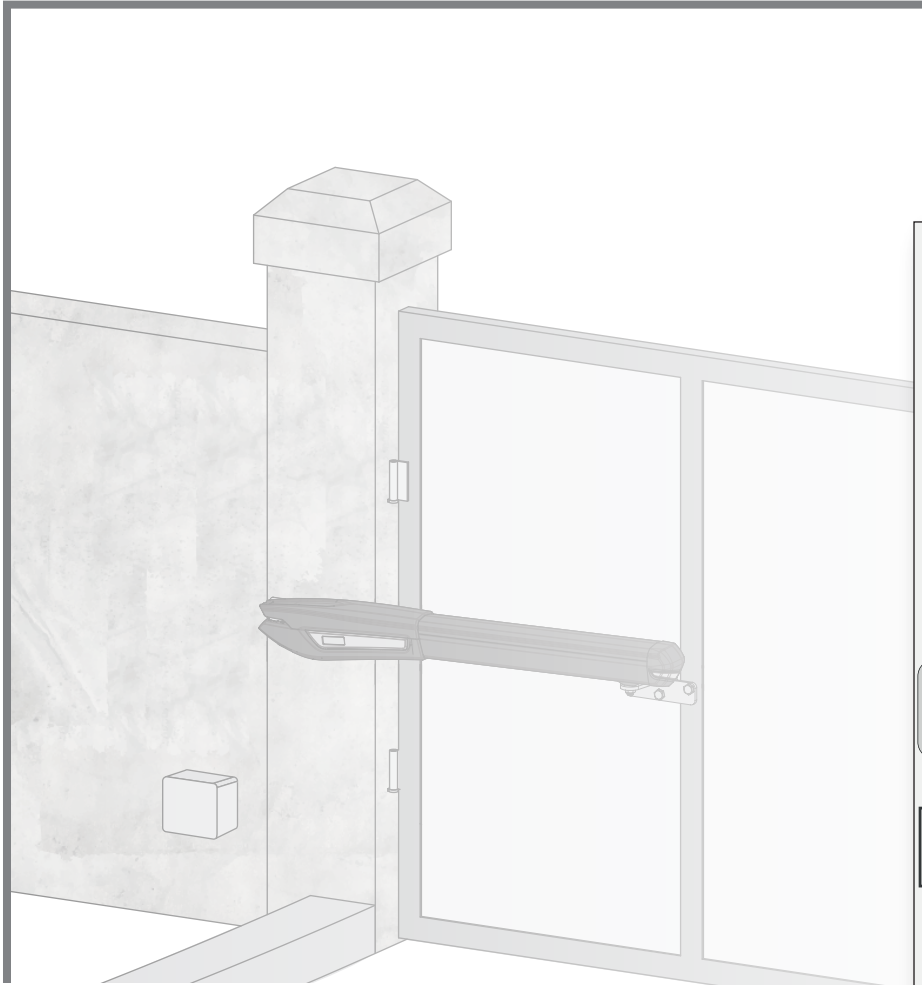

# 00. CONTENT

## INDEX

<b>01. SAFETY INSTRUCTIONS</b>	<b>1B</b>
<b>02. THE CONTROL BOARD</b>	
TECHNICAL SPECIFICATIONS	4A
LEDs	4A
CONNECTORS	4B
<b>03. INSTALLATION</b>	
INSTALLATION MAP	5
BASE INSTALLATION PROCESS	6A
<b>04. PROGRAMMING</b>	
PROGRAMMING AND DELETE REMOTE CONTROLS	6B
P MENUS	7A
E MENUS	7B
<b>05. PROGRAMMING "P"</b>	
P0	8A
P1 - P2	8B
P3 - P4	9A
P5 - P6	9B
P7 - P8	10A
P9	10B
<b>06. PROGRAMMING "E"</b>	
E0	10B
E1 - E2 - E3	11A
E4 - E5	11B
E6 - E7	12A
E8 - E9	12B
<b>07. DISPLAY</b>	
DISPLAY INDICATIONS	13A
<b>08. COMPONENTS TEST</b>	
MOTOR 230V/110V	13B
<b>09. TROUBLESHOOTING</b>	
FINAL CONSUMERS INSTRUCTIONS AND SPECIALIZED INSTALLERS	14

# 01. SAFETY INSTRUCTIONS

## ATTENTION:



This product is certified in accordance with European Community (EC) safety standards.



This product complies with Directive 2011/65/EU of the European Parliament and of the Council, of 8 June 2011, on the restriction of the use of certain hazardous substances in electrical and electronic equipment and with Delegated Directive (EU) 2015/863 from Commission.



(Applicable in countries with recycling systems).  
This marking on the product or literature indicates that the product and electronic accessories (eg. Charger, USB cable, electronic material, controls, etc.) should not be disposed of as other household waste at the end of its useful life. To avoid possible harm to the environment or human health resulting from the uncontrolled disposal of waste, separate these items from other types of waste and recycle them responsibly to promote the sustainable reuse of material resources. Home users should contact the dealer where they purchased this product or the National Environment Agency for details on where and how they can take these items for environmentally safe recycling. Business users should contact their vendor and check the terms and conditions of the purchase agreement. This product and its electronic accessories should not be mixed with other commercial waste.



This marking indicates that the product and electronic accessories (eg. charger, USB cable, electronic material, controls, etc.) are susceptible to electric shock by direct or indirect contact with electricity. Be cautious when handling the product and observe all safety procedures in this manual.

# 01. SAFETY INSTRUCTIONS

## **GENERAL WARNINGS**

- This manual contains very important safety and usage information. very important. Read all instructions carefully before beginning the installation/usage procedures and keep this manual in a safe place that it can be consulted whenever necessary.
- This product is intended for use only as described in this manual. Any other enforcement or operation that is not mentioned is expressly prohibited, as it may damage the product and put people at risk causing serious injuries.
- This manual is intended firstly for specialized technicians, and does not invalidate the user's responsibility to read the "User Norms" section in order to ensure the correct functioning of the product.
- The installation and repair of this product may be done by qualified and specialized technicians, to assure every procedure are carried out in accordance with applicable rules and norms. Nonprofessional and inexperienced users are expressly prohibited of taking any action, unless explicitly requested by specialized technicians to do so.
- Installations must be frequently inspected for unbalance and the wear signals of the cables, springs, hinges, wheels, supports and other mechanical assembly parts.
- Do not use the product if it is necessary repair or adjustment is required.
- When performing maintenance, cleaning and replacement of parts, the product must be disconnected from power supply. Also including any operation that requires opening the product cover.
- The use, cleaning and maintenance of this product may be carried out by any persons aged eight years old and over and persons whose physical, sensorial or mental capacities are lower, or by persons without any knowledge of the product, provided that these are supervision and instructions given by persons with experienced in terms of usage of the product in a safe manner and who understands the risks and dangers involved.

- Children shouldn't play with the product or opening devices to avoid the motorized door or gate from being triggered involuntarily.

## **WARNINGS FOR TECHNICIANS**

- Before beginning the installation procedures, make sure that you have all the devices and materials necessary to complete the installation of the product.
- You should note your Protection Index (IP) and operating temperature to ensure that is suitable for the installation site.
- Provide the manual of the product to the user and let them know how to handle it in an emergency.
- If the automatism is installed on a gate with a pedestrian door, a door locking mechanism must be installed while the gate is in motion.
- Do not install the product "upside down" or supported by elements do not support its weight. If necessary, add brackets at strategic points to ensure the safety of the automatism.
- Do not install the product in explosive site.
- Safety devices must protect the possible crushing, cutting, transport and danger areas of the motorized door or gate.
- Verify that the elements to be automated (gates, door, windows, blinds, etc.) are in perfect function, aligned and level. Also verify if the necessary mechanical stops are in the appropriate places.
- The central must be installed on a safe place of any fluid (rain, moisture, etc.), dust and pests.
- You must route the various electrical cables through protective tubes, to protect them against mechanical exertions, essentially on the power supply cable. Please note that all the cables must enter the central from the bottom.
- If the automatism is to be installed at a height of more than 2,5m from the ground or other level of access, the minimum safety and health requirements for the use of work equipment workers at the work of Directive 2009/104/CE of European Parliament and of the Council of 16

# 01. SAFETY INSTRUCTIONS

September 2009.

- Attach the permanent label for the manual release as close as possible to the release mechanism.
- Disconnect means, such as a switch or circuit breaker on the electrical panel, must be provided on the product's fixed power supply leads in accordance with the installation rules.
- If the product to be installed requires power supply of 230Vac or 110Vac, ensure that connection is to an electrical panel with ground connection.
- The product is only powered by low voltage safety with central (only at 24V motors)

## WARNINGS FOR USERS

- Keep this manual in a safe place to be consulted whenever necessary.
- If the product has contact with fluids without being prepared, it must immediately disconnect from the power supply to avoid short circuits, and consult a specialized technician.
- Ensure that technician has provided you the product manual and informed you how to handle the product in an emergency.
- If the system requires any repair or modification, unlock the automatism, turn off the power and do not use it until all safety conditions have been met.
- In the event of tripping of circuits breakers or fuse failure, locate the malfunction and solve it before resetting the circuit breaker or replacing the fuse. If the malfunction is not repairable by consult this manual, contact a technician.
- Keep the operation area of the motorized gate free while the gate in in motion, and do not create strength to the gate movement.
- Do not perform any operation on mechanical elements or hinges if the product is in motion.

## RESPONSABILITY

- Supplier disclaims any liability if:
  - Product failure or deformation result from improper installation use or maintenance!
  - Safety norms are not followed in the installation, use and maintenance of the product.
  - Instructions in this manual are not followed.
  - Damaged is caused by unauthorized modifications
  - In these cases, the warranty is voided.

## **MOTORLINE ELECTROCELOS SA.**

Travessa do Sobreiro, nº29  
4755-474 Rio Côvo (Santa Eugénia)  
Barcelos, Portugal

## SYMBOLS LEGEND:



• Important safety notices



• Useful information



• Programming information



• Potentiometer information



• Connectors information



• Buttons information

## 02. CONTROL BOARD

### TECHNICAL SPECIFICATIONS

The MC52 is a single-phase control board with built-in radio control system designed for the automation of swing gates.

	110V version	230V version
• <b>Power Supply</b>	110Vac 60Hz	230Vac 50-60Hz
• <b>Flashing light's output</b>	110Vac 60Hz 500W max.	230Vac 50Hz 500W max.
• <b>RGB Flashing light's output</b>	24Vdc 100mA max.	
• <b>Motor's output</b>	110Vac 60Hz 500W max.	230Vac 50-60Hz 500W max.
• <b>Auxiliary accessories output</b>	24Vdc 8W max.	
• <b>Security and BT Remote controls</b>	24Vdc	
• <b>Working temperature</b>	-25°C to +55°C	
• <b>Incorporated Radio Receptor</b>	433,92 Mhz	
• <b>OP Remote controls</b>	12bits or Rolling Code	
• <b>Maximum Memory Capacity</b>	100 (full opening) - 100 (pedestrian opening)	
• <b>Control board Dimensions</b>	125mm x 140mm	

### LEDs

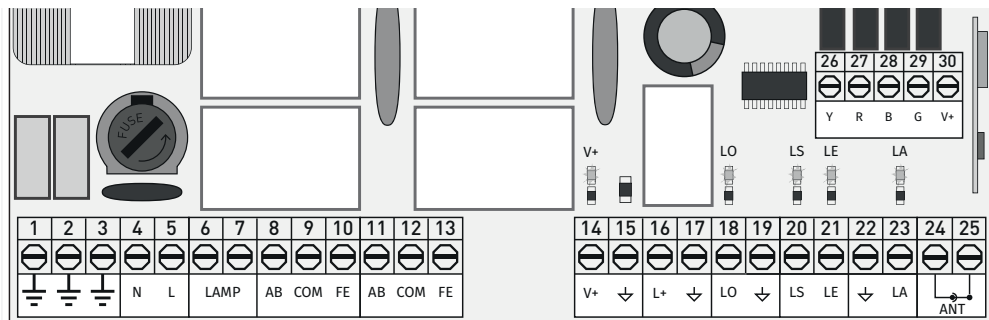

LEDs

- V+ • LED On indicates that the line for V+ output is OK.
- LS • LED On when pedestrian opening is active.
- LO • LED On when full opening is active.
- LA • LED on when the photocell is active (P6 active) or the ↓ LA circuit is closed.
- LE • LED on when the photocells are active (P5 active) or the ↓ LE circuit is closed.

## 02. CONTROL BOARD

### CONNECTORS



Make sure which version you are using (110Vac or 230Vac).

CN1	01 • Grounding connection 02 • Grounding connection 03 • Grounding connection		
	04 • 110/230Vac (Neutral) (N) line input 05 • 110/230Vac (Phase) (L) line input	<b>110/230Vac Power Supply</b>	
	06 • Flashing light Output - 110/230Vac 500W 07 • Flashing light Output - 110/230Vac 500W	<b>Courtesy light or Flashing light:</b> This output allows the connection of a courtesy light or a Flashing light.	
	08 • Motor 1 Output - Opening - 110/230Vac 500W 09 • Motor 1 Output - Common - 110/230Vac 500W 10 • Motor 1 Output - Closing - 110/230Vac 500W	<b>Motor 1</b>	
CN2	11 • Motor 2 Output - Opening - 110/230Vac 500W 12 • Motor 2 Output - Common - 110/230Vac 500W 13 • Motor 2 Output - Closing - 110/230Vac 500W	<b>Motor 2</b>	
	14 • 24Vdc 200mA max. Power supply 15 • 24Vdc 200mA max. Power supply	<b>24Vdc Auxiliary Power Supply</b>	
	16 • Electric lock Output 12/24Vdc 15W 17 • Electric lock Output 12/24Vdc 15W	<b>Electric lock:</b> This output allows the connection of an electric lock. <b>Note •</b> The indicated power is for 2 sec. impulses.	
	18 • Total opening Input (NA) 19 • Common 20 • Pedestrian opening Input (NA)	<b>Pushbuttons:</b> This circuit allows the connection of pushbuttons for full or pedestrian opening.	
	21 • Photocells 1 (NC) 22 • Common 23 • Photocells 2 (NC) 24 • Antenna 25 • GND	<b>Safety circuits:</b> This circuit allows the connection of photocells. Its operation depending on the configuration of the P5 and P6 menus (check page 9A). <b>Antenna</b>	
	CN3	26 • Output Y (GND) 27 • Output R (GND) 28 • Output B (GND) 29 • Output G (GND) 30 • Auxiliary output for Flashing light or 24Vdc LED	Open collector for the management of auxiliary functions: <b>Output Y</b> is activated in intermittent mode, only with the gate <b>closed</b> . <b>Output R</b> is activated in intermittent mode, only in the <b>closing</b> phase. <b>Output B</b> is activated in intermittent mode, only during the <b>pause</b> time. <b>Output G</b> is activated in intermittent mode, only during the <b>opening</b> phase.

4A

EN

4B

EN

# 03. INSTALLATION

## INSTALLATION MAP

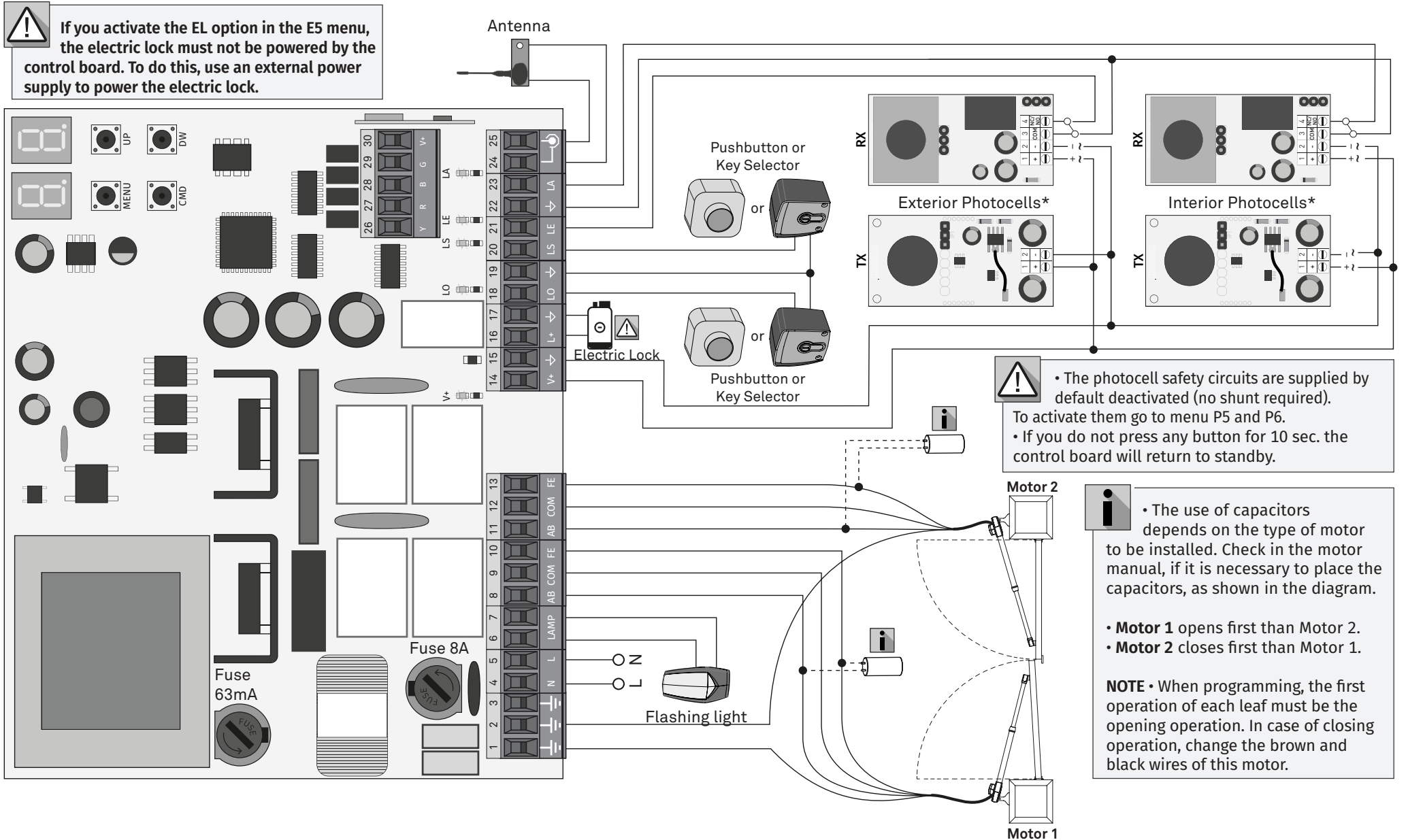

## 03. INSTALLATION

### BASE INSTALLATION PROCESS



The installation process assumes that the gate already has mechanical or electrical limit switches installed.

- 01 • Connect all accessories according to the connections diagram (page 5).
- 02 • Connect the control board to a 230V power supply (terminals 4 and 5 - CN1).
- 03 • Check if the gate movement is the same as shown on the display.
- 04 • Make a course programming - menu **P0** (page 8A).
- 05 • If necessary, adjust the deceleration time of the gate at opening and closing - menu **P1** (page 8A).
- 06 • Adjust the gate force - menu **P2** (page 8B).
- 07 • Re-program the course - menu **P0** (page 8A).
- 08 • Enable or disable the use of Photocells in menu **P5** and **P6** (page 9A).
- 09 • Program a remote control (page 6B).

The control board is now fully configured!  
Check the pages of the menu programming if you want to configure other features of the Control board.

## 04. PROGRAMMING

### PROGRAMMING AND DELETE REMOTE CONTROLS

**SU** Remote controls programming for total opening.

**SP** Remote controls programming for pedestrian opening.

#### • PROGRAMMING REMOTE CONTROL

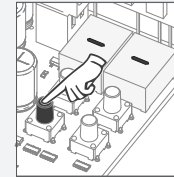

01 • Press the cmd button for 3 sec.

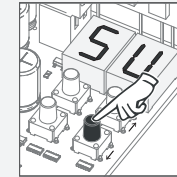

02 • Select (SU) using ↑ ↓.

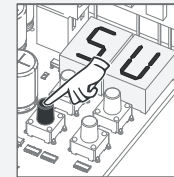

03 • Press cmd once to confirm.

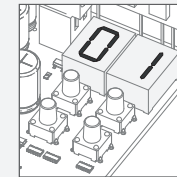

04 • The first free position appears.



05 • Press the remote control button you want to program. The display will blink and move to the next free location.

#### • ERASE REMOTE CONTROL

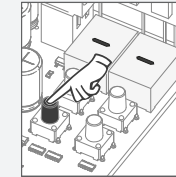

01 • Press the cmd button for 3 sec.

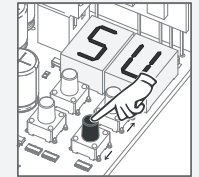

02 • Select (SU) using ↑ ↓.

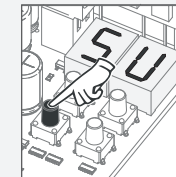

03 • Press cmd once to confirm.

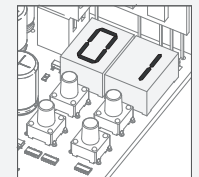

04 • Use ↓ ↑ to select the remote control location you want to delete.

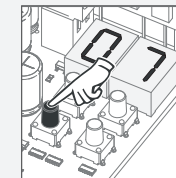

05 • Press cmd for 3 sec and the location will be empty. The display will blink and the position will be free.

#### • ERASE ALL THE REMOTE CONTROL

01 • Press the cmd button for 10 sec.

02 • The display will show **SU**.

03 • **SU** will flash.

04 • **LU** flashes, confirming that all remote control have been deleted.



• If you do not press any button for 10 sec. the control board will return to standby.



# 04. PROGRAMMING

## P MENUS

- We can only enter programming with the gate stopped (electrically).
- To access the P menu press the MENU button for 3 sec.
- Use ↓↑ to navigate through the menus.
- Press MENU when you want to confirm access to a menu.
- Press ↓↑ simultaneously to exit programming.

MENU	FUNCTION	MIN.	MAX.	STATE	FACTORY VALUE	PAGE
P0	Course Programming	-	-	MR Manual Programming	-	8A
				MD 01 1 motor MD 02 2 motors	02	
P1	Deceleration time adjustment	0s	25s	dR Opening deceleration (Leaf 1)	03	8A
				dF Closing deceleration (Leaf 1)		
				bR Opening deceleration (Leaf 2)		
				bF Closing deceleration (Leaf 2)		
P2	Force adjustment	0	9	FD Force adjustment	04	8B
P3	Pedestrian Course time	0s	99s	Time adjustment in pedestrian course	10	8B
P4	Pause time and gates delay	0s	99s	RF Total pause time	00	8B
		0s	99s	RP Pedestrian pause time	00	
		0s	25s	Ro Opening gates delay	02	
		0s	25s	Rc Closing gates delay	02	
		0	1	LE 00 Disables LE 01 Active	00	
P5	Photocells 1 programming	0	1	HE 00 In Opening HE 01 In Closing	01	9A
		0	2	HL 00 Invert HL 01 Stop HL 02 Invert 2 sec. and Stop	00	
		0	1	LR 00 Disables LR 01 Active	00	
P6	Photocells 2 programming	0	1	HE 00 In Opening HE 01 In Closing	00	9A
		0	2	HL 00 Invert HL 01 Stop HL 02 Invert 2 sec. and Stop HL 03 Stop, continue if you remove the obstacle	01	
		0	2	00 Automatic mode function 01 Step by step mode function 02 Condominium mode function	00	
P7	Operating logic	0	2	00 Flashing (opening and closing) 01 Step by step mode function 02 Courtesy light	00	9B
P8	Flashing light	0	2	00 Distance PGM OFF 01 Distance PGM ON	00	9B
P9	Remote programming	0	1	00 Distance PGM OFF	00	9B
				01 Distance PGM ON		

7A

EN

# 04. PROGRAMMING

## E MENUS

MENU	FUNCTION	MIN..	MAX.	STATE	FACTORY VALUE	PAGE.	
E0	Human presence	0	1	HP 00 Deactivates Human presence HP 01 Activates Human presence	00	10A	
				PL 00 Disables push buttons mode PL 01 Activates push buttons mode			
E1	Soft start	0	1	00 Deactivates Soft start 01 Activates Soft start	00	10A	
E2	Courtesy light time	0m	99m	Courtesy light time adjustment (minutes)	00	10A	
E3	Follow me	-	-	00 Deactivates follow me 01 Follow me does not act when the gate is opening. It only works when it is open. 02 Follow me acts when the gate is open and when it is open.	00	10A	
E4	Course time adjustment	0m	3m	Opening course time (minutes) - Leaf 1	00	10B	
		0s	59s	Opening course time (seconds) - Leaf 1	30		
		0m	3m	Closing course time (minutes) - Leaf 1	00		
		0s	59s	Closing course time (seconds) - Leaf 1	30		
		0m	3m	Opening course time (minutes) - Leaf 2	00		
		0s	59s	Opening course time (seconds) - Leaf 2	30		
		0m	3m	Closing course time (minutes) - Leaf 2	00		
		0s	59s	Closing course time (seconds) - Leaf 2	30		
E5	Brake/Lock/Strokes	0	1	E6 00 Disables electronic brake E6 01 Active electronic brake	00	10B	
				EL 00 Activates electric lock on opening 2 sec. EL 01 Activates electric lock whenever moving			
				PO 00 Disables opening push PO 01 Active opening push			
				PC 00 Disables closing push PC 01 Active closing push			
E6	Deceleration Speed	0	9	Deceleration Speed adjustment	05	10B	
E7	Manuevers counter	-	-	Shows the number of manuevers	-	10B	
E8	Reset - Restore factory settings	0	1	00 Deactivated 01 Reset activated	00	11A	
E9	RGB Output	-	-	00 Continued output 01 Intermittent output	00	11A	
REMOTE CONTROL							
SU	Remote control programming for total opening.						6B
SP	Remote control programming for pedestrian opening.						6B

7B

EN



## 04. PROGRAMMING "P"

## P0 COURSE PROGRAMMING

<b>PA</b>	<b>P0</b>
<b>Course Manual Programming</b> This menu allows you to manually set the course of the leaf/leaves.	<b>Number of Motors</b> Allows you to define the number of motors connected to the control board
Default value (NA)	Default value (02)

DIRECTION OF DISPLAY ROTATION	COURSE PROGRAMMING OF TWO MOTORS
<b>00</b>	Normal rotation - leaf 1 starts opening (normal speed) Slow rotation - leaf 1 goes into opening slowdown (slowdown speed)
<b>01</b>	Normal rotation - leaf 1 stops and leaf 2 starts opening (normal speed) Slow rotation - leaf 2 goes into opening slowdown (slowdown speed)
<b>02</b>	Normal rotation - leaf 2 stops and starts closing (normal speed) Slow rotation - leaf 2 goes into closing speed (slowdown speed)
<b>03</b>	Normal rotation - leaf 2 stops and leaf 1 starts opening (normal speed) Slow rotation - leaf 1 goes into closing slowdown (slowdown speed)
COURSE PROGRAMMING OF ONE MOTOR (PEDESTRIAN)	
<b>04</b>	Normal rotation - leaf starts opening (normal speed) Slow rotation - the leaf goes into opening slowdown (slowdown speed)
<b>05</b>	Normal rotation - the leaf stops and starts closing (normal speed)
<b>06</b>	Slow rotation - the leaf goes into closing slowdown (slowdown speed)

### Manual programming:

- 01 • Press MENU for 2 sec. until **P0** appears.
- 02 • Press MENU once until **PA** appears.
- 03 • Press MENU (or remote control) to start programming the opening time.

2 MOTORS (PA = 02)	1 MOTOR (PEDESTRIAN) (PA = 01)
<b>04</b> • Press MENU to start slowdown. <b>05</b> • Press MENU to stop leaf 1 (leaf 2 starts opening automatically). <b>06</b> • Press MENU to start slowdown. <b>07</b> • Press MENU to finish opening and start closing leaf 2. <b>08</b> • Press MENU to start slowdown. <b>09</b> • Press MENU to stop leaf 2 (leaf 1 starts closing automatically). <b>10</b> • Press MENU to start slowdown. <b>11</b> • Press MENU to finish closing leaf 1.	<b>04</b> • Press MENU to start the opening slowdown of the leaf. <b>05</b> • Press MENU to stop the leaf and start programming the closing time. <b>06</b> • Press MENU to start the closing slowdown of the leaf. <b>07</b> • Press MENU once to display <b>P0</b> , leaf 1 stops. <b>08</b> • Use UP and DW to display <b>P1</b> to exit programming mode. <b>09</b> • Use UP and DW to stay in Standby.

Display will show **00** signaling that leaves are closed.



You can use the remote instead of the MENU button. Whenever a leaf touches a stop, wait 1 second before clicking on the MENU.

## 05. PROGRAMMING "P"

## P1 DECELERATION TIME ADJUSTMENT



Whenever there is a reversal of the direction of travel, the preset deceleration time is increased by 2 sec. up to 25 sec. maximum.

This menu allows you to set the deceleration time of each leaf at opening and closing.

<b>0A</b>	<b>0F</b>
<b>Slowing down on opening leaf 1</b> It allows to define the time that the gate will act with slowdown in the opening.	<b>Slowing down on closing leaf 1</b> It allows to define the time that the gate will act with slowdown in the closing.
<b>0B</b>	<b>0E</b>
<b>Slowing down on opening leaf 2</b> It allows to define the time that the gate will act with slowdown in the opening.	<b>Slowing down on closing leaf 2</b> It allows to define the time that the gate will act with slowdown in the closing.

min. max. (Default value 3)

- 01 • Press MENU for 2 sec. until it appears **P0**.
- 02 • Use UP until appears **P1**.
- 03 • Press Menu will appear **0A**. Use UP or DW to navigate the parameters.
- 04 • Press MENU to edit the chosen parameter value.
- 05 • The currently set value appears. Use UP and DW to change the value.
- 06 • Press MENU to save the new value.

## 05. PROGRAMMING "P"

## P2 FORCE ADJUSTMENT

This menu allows you to set the force that is injected into the motor when it moves at normal speed. The default value is 4.

- 01 • Press MENU for 2 sec. until it appears **P0**.
- 02 • Use UP until appears **P2**.
- 03 • Press Menu will appear **F0**.
- 04 • Press MENU to edit value.
- 05 • The currently set value appears. Use UP and DW to change the value.
- 06 • Press MENU to save the new value.

## 05. PROGRAMMING "P"

### P3 PEDESTRIAN COURSE TIME

Allows you to set the pedestrian course time.  
The default value is 10.

- 01 • Press MENU for 2 sec. until it appears *P0*.
- 02 • Use UP until appears *P3*.
- 03 • Press Menu the value set by the factory will appear.
- 04 • Press MENU to edit the value.
- 05 • Use UP and DW to change the value.
- 06 • Press MENU to save the new value.

## 05. PROGRAMMING "P"

### P4 PAUSE TIME AND GATES DELAY



When the values are at zero, there is no automatic closing.

<i>AF</i>	<i>AP</i>	<i>AE</i>	<i>AO</i>
<b>Full closing pause time adjustment</b> This menu allows you to set the total opening pause time.	<b>Pedestrian closing pause time adjustment</b> Allows you to set the pause time at the pedestrian opening.	<b>Gate delay in closing</b> Allows you to set the delay time for closing leaf 1 relative to leaf 2.	<b>Gate delay in opening</b> Allows you to set the delay time for opening leaf 2 relative to leaf 1.
 (Default value 0)	 (Default value 0)	 (Default value 2)	 (Default value 2)

- 01 • Press MENU for 2 sec. until it appears *P0*
- 02 • Use UP until appears *P4*.
- 03 • Press Menu will appear *AF*. Use UP or DW to navigate the parameters.
- 04 • Press MENU to edit the chosen parameter value.
- 05 • The currently set value appears. Use UP and DW to change the value.
- 06 • Press MENU to save the new value.

## 05. PROGRAMMING "P"

### P5 PHOTOCELLS 1 PROGRAMMING

<i>EE</i>	<i>HE</i>	<i>HE</i>
<b>00 (deactivate)</b> <b>01 (active)</b> Enable or disable security.	<b>00 (photocells in opening)</b> <b>01 (photocells in closing)</b> Define if this security will act on opening or closing.	<b>00 (the movement of the gate is reversed)</b> <b>01 (gate movement stops and resumes 5 sec after security is disabled)</b> <b>02 (the movement of the gate reverses for 2 seconds and stops)</b> Define the behavior that the gate will have when this security is activated.
(Default value 0)		

- 01 • Press MENU for 2 sec. until it appears *P0*
- 02 • Use UP until appears *P5*.
- 03 • Press Menu will appear *EE*. Use UP or DW to navigate the parameters.
- 04 • Press MENU to edit the chosen parameter value.
- 05 • The currently set value appears. Use UP and DW to change the value.
- 06 • Press MENU to save the new value.

## 05. PROGRAMMING "P"

### P6 PHOTOCELLS 2 PROGRAMMING

<i>EA</i>	<i>HE</i>	<i>HE</i>
<b>00 (deactivate)</b> <b>01 (active)</b> Enable or disable security.	<b>00 (photocells in opening)</b> <b>01 (photocells in closing)</b> Define if this security will act on opening or closing.	<b>00 (the movement of the gate is reversed)</b> <b>01 (gate movement stops and resumes 5 sec after security is disabled)</b> <b>02 (the movement of the gate reverses for 2 seconds and stops)</b> <b>03 (whenever the photocells are obstructed, the gate will stop working. As soon as the obstacle is removed, when closing, the gate reverses its movement and when opening, it continues to open)</b> Define the behavior that the gate will have when this security is activated.
(Default value 0)		

- 01 • Press MENU for 2 sec. until it appears *P0*.
- 02 • Use UP until appears *P5*.
- 03 • Press Menu will appear *EA*. Use UP or DW to navigate the parameters.
- 04 • Press MENU to edit the chosen parameter value.
- 05 • The currently set value appears. Use UP and DW to change the value.
- 06 • Press MENU to save the new value.

## 05. PROGRAMMING "P"

### P7 OPERATING LOGIC

This menu allows to set the operating logic of the automation.

00	01	02
<b>Automatic Mode</b> Whenever there is an order the movement is reversed.	<b>Step by step mode</b> 1st impulse - OPEN 2nd impulse - STOP 3rd impulse - CLOSE 4th impulse - STOP If it is fully open and timed, it closes.	<b>Condominium Mode</b> Does not respond to orders during opening and pause time.
(Default value 00)		

- 01 • Press MENU for 2 sec. until it appears P0.
- 02 • Use UP until appears P7.
- 03 • Press Menu will appear 00.
- 04 • Press MENU to edit the value.
- 05 • Use UP and DW to change the value.
- 06 • Press MENU to save the new value.

## 05. PROGRAMMING "P"

### P8 FLASHING LIGHT

This menu allows you to set the operation mode of the flashing light (LAMP).

00	01	02
<b>Flashing</b> (opening and closing) During the opening/closing movement of the gate, the flashing light will work intermittently.	<b>Step by step mode</b> The opening and closing movement, the flashing light is permanently on.	<b>Courtesy light</b> The light will stay on for the time set in the E2 menu.
(Default value 00)		

- 01 • Press MENU for 2 sec. until it appears P0.
- 02 • Use UP until appears P8.
- 03 • Press Menu will appear 00.
- 04 • Press MENU to edit the value.
- 05 • Use UP and DW to change the value.
- 06 • Press MENU to save the new value.

## 05. PROGRAMMING "P"

### P9 REMOTE PROGRAMMING

Allows you to activate/deactivate the programming of new remote controls without directly accessing the control board, using a previously memorized remote control.

- 01 • Press MENU for 2 sec. until it appears P9.
- 02 • Use UP until appears P0.
- 03 • Press Menu will appear 00.
- 04 • Press MENU to edit the value.
- 05 • Use UP and DW to change the value.
- 06 • Press MENU to save the new value.

(Default value 00)

#### Remote Programming Operation (PGM ON):



- Press the buttons indicated in the image simultaneously for 10 seconds and the flashing light will flash (the 1st free position appears in the display).  
 Each time you store 1 remote controls, the control board will exit remote programming. If you want to memorize more remote control, you will always have to repeat the process of pressing the remote controls buttons simultaneously for 10 seconds for each new remote control.

## 06. PROGRAMMING "E"

### E0 HUMAN PRESENCE

HP	PL									
<b>00 (deactivate)</b> <b>01 (active)</b> Enable or disable human presence.	<b>00 (deactivate)</b> <b>01 (active)</b> Allows you to activate or deactivate the pushbutton mode.									
<b>Note</b> • With active human presence RF remote controls do not work.	<table border="1"> <thead> <tr> <th></th> <th>LS</th> <th>LO</th> </tr> </thead> <tbody> <tr> <td>01 ACTIVE</td> <td>Full closing</td> <td>Full opening</td> </tr> <tr> <td>00 DEACTIVATE</td> <td>Pedestrian maneuvers</td> <td>Total maneuvers</td> </tr> </tbody> </table>		LS	LO	01 ACTIVE	Full closing	Full opening	00 DEACTIVATE	Pedestrian maneuvers	Total maneuvers
	LS	LO								
01 ACTIVE	Full closing	Full opening								
00 DEACTIVATE	Pedestrian maneuvers	Total maneuvers								
(Default value 00)										

- 01 • Press MENU for 10 sec. until it appears E0.
- 02 • Press Menu will appear HP. Use UP or DW to navigate the parameters.
- 03 • Press MENU to edit the chosen parameter value.
- 04 • The currently set value appears. Use UP and DW to change the value.
- 05 • Press MENU to save the new value.

## 06. PROGRAMMING "E"

### E.1 SOFT START

Enables or disables the soft start. With the soft start function activated, at each start of movement the control board will control the motor start, increasing the speed gradually in the first second of operation.

The default value is 0 (deactivated).

- 01 • Press MENU for 10 sec. until it appears **E0**.
- 02 • Use UP until appears **E1**.
- 03 • Press Menu will appear **00**.
- 04 • Press MENU to edit the value.
- 05 • Use UP and DW to change the value.
- 06 • Press MENU to save the new value.

## 06. PROGRAMMING "E"

### E.2 COURTESY LIGHT TIME



This parameter is only activated if option 2 is selected in P8.

This menu allows you to adjust the courtesy light time for all positions of the gate (closed, opened and stopped). The default value is 0 (Courtesy light deactivated)

- 01 • Press MENU for 10 sec. until it appears **E0**.
- 02 • Use UP until appears **E2**.
- 03 • Press Menu will appear **00**.
- 04 • Press MENU to edit the value.
- 05 • Use UP and DW to change the value.
- 06 • Press MENU to save the new value.

## 06. PROGRAMMING "E"

### E.3 FOLLOW ME

Allows you to activate the Follow me option. With this option activated, the control board, when in the open position or in opening, gives a closing order of 5 sec. after the safety device detects the passage of an object / user.

**00 function disabled**  
**01 function activated after opening**  
**02 function activated on opening**

(Default value 00)

- 01 • Press MENU for 10 sec. until it appears **E0**.
- 02 • Use UP until appears **E3**.
- 03 • Press Menu will appear **00**.
- 04 • Press MENU to edit the value.
- 05 • Use UP and DW to change the value.
- 06 • Press MENU to save the new value.

## 06. PROGRAMMING "E"

### E.4 COURSE TIME ADJUSTMENT

It allows to adjust the working time for the opening and closing courses of the two leaves.

Leaf 1			
<b>E0</b>	<b>E5</b>	<b>E0</b>	<b>E5</b>
<b>Opening course time (minutes)</b>	<b>Opening course time (seconds)</b>	<b>Closing course time (minutes)</b>	<b>Closing course time (seconds)</b>
(Default value 0)	(Default value 15)	(Default value 0)	(Default value 15)
Leaf 2			
<b>E0</b>	<b>E5</b>	<b>E0</b>	<b>E5</b>
<b>Opening course time (minutes)</b>	<b>Opening course time (seconds)</b>	<b>Closing course time (minutes)</b>	<b>Closing course time (seconds)</b>
(Default value 0)	(Default value 15)	(Default value 0)	(Default value 15)

- 01 • Press MENU for 10 sec. until it appears **E0**.
- 02 • Use UP until appears **E4**.
- 03 • Press Menu will appear **E0**. Use UP or DW to navigate the parameters.
- 04 • Press MENU to edit the chosen parameter value.
- 05 • The currently set value appears. Use UP and DW to change the value.
- 06 • Press MENU to save the new value.

## 06. PROGRAMMING "E"

### E.5 BRAKE/LOCK/PUSH

It allows to activate or deactivate the functions of the electronic brake, the lock's operating mode and to activate or deactivate pushes on opening and closing.

<b>E6</b>	<b>E0</b>	<b>P0</b>	<b>P2</b>
<b>00 (disables electronic brake)</b> <b>01 (activates electronic brake)</b>	<b>00 (active lock on opening 2 sec.)</b> <b>01 (activates lock whenever in motion)</b>	<b>00 (disable opening push)</b> <b>01 (active opening push)</b>	<b>00 (disables closing push)</b> <b>01 (active closing push)</b>
Allows you to activate the electronic brake.	Allows you to select the lock's operating mode. The default value is 0 (2 second pulse on opening). <b>Note: If you select option 2, you must take into account the maximum current value provided by the control board.</b>	Allows you to activate the opening push (ram).	Allows you to activate the closing push.
(Default value 0)	(Default value 0)	(Default value 0)	(Default value 0)

## 06. PROGRAMMING "E"

### E5 BRAKE/LOCK/PUSH

- 01 • Press MENU for 10 sec. until it appears E0.
- 02 • Use UP until appears E5.
- 03 • Press Menu will appear E6. Use UP or DW to navigate the parameters.
- 04 • Press MENU to edit the chosen parameter value.
- 05 • The currently set value appears. Use UP and DW to change the value.
- 06 • Press MENU to save the new value.

## 06. PROGRAMMING "E"

### E6 DECELERATION SPEED

This menu allows you to adjust the deceleration speed.  
The higher the slowdown level, the faster the slowdown.  
The default value is 4.

- 01 • Press MENU for 10 sec. until it appears E0.
- 02 • Use UP until appears E6.
- 03 • Press Menu the value set by the factory will appear.
- 04 • Press MENU to edit the value.
- 05 • Use UP and DW to change the value.
- 06 • Press MENU to save the new value.

## 06. PROGRAMMING "E"

### E7 MANUEVERS COUNTER

This menu allows you to view the number of maneuvers performed.  
(complete maneuver means opening and closing).

⚠ **Resetting the control board does not clear the maneuver count.**

**Example:** 13456 maneuvers  
01- Hundred thousand / 34- Thousands / 56- Dozens

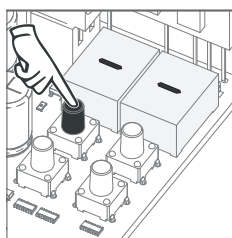

01 • Press MENU for 10 seconds.

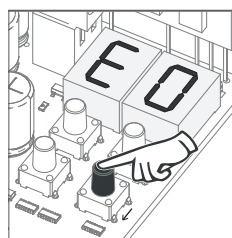

02 • E0 appears.  
Press UP until appears E7.

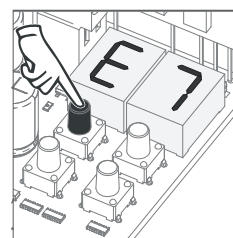

03 • Press MENU.

## 06. PROGRAMMING "E"

### E7 MANUEVERS COUNTER

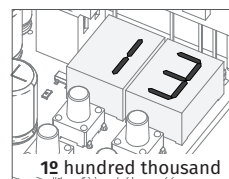

display flashes

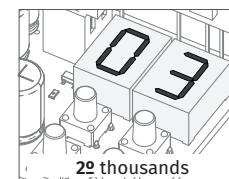

20 thousands

display flashes



30 dozens

- 04 • The maneuvers count is displayed in the following order (example: 130 371):

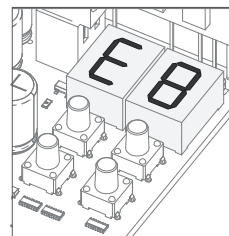

- 05 • E8 appears.

## 06. PROGRAMMING "E"

### E8 RESET - RESET FACTORY VALUES

This menu allows you to reset to factory defaults.  
The default value is 0 (deactivated).

- 01 • Press MENU for 10 sec. until it appears E0.
- 02 • Use UP until appears E8.
- 03 • Press Menu will appear 00.
- 04 • Press MENU to edit the value.
- 05 • Use UP and DW to change the value.
- 06 • Press MENU to save the new value.

## 06. PROGRAMMING "E"

### E9 RGB OUTPUT

This menu allows you to set the operation mode of RGB outputs.  
The default value is 0 (continuous output).

- 01 • Press MENU for 10 sec. until it appears E0.
- 02 • Use UP until appears E9.
- 03 • Press Menu will appear 00.
- 04 • Press MENU to edit the value.
- 05 • Use UP and DW to change the value.
- 06 • Press MENU to save the new value.

## 07. DISPLAY

### DISPLAY INDICATIONS

88	IN STOP POSITION, FULLY OPENED
88	IN STOP POSITION, MIDDLE POSITION
88	IN STOP POSITION, FULLY CLOSED
80	TOTAL OPENING BUTTON PRESSED
85	PEDESTRIAN OPENING BUTTON PRESSED
OP	CONTROL BOARD PERFORMS OPENING COURSE
CC	CONTROL BOARD PERFORMS CLOSING COURSE
FO	END OF OPENING COURSE TIME
FC	END OF CLOSING COURSE TIME
88	ALL REMOTE CONTROLS DELETED
00 01 02	REMOTE CONTROL ADDED IN THE INDICATED POSITION
8E	OBSTRUCTED PHOTOCELL
8A	OBSTRUCTED PHOTOCELL
8F	IN PAUSE TIME
8P	IN PEDESTRIAN PAUSE TIME

## 08. COMPONENTS TEST

### 230V/110V MOTOR

To detect if the problem is in the control board or in the motor, sometimes it's necessary to conduct tests with a direct connection to a 230V/110V power supply.

For this, it's necessary to interpose a capacitor on the connection so that the motor can work (check the capacitor type to be used in the product's manual). In the below diagram is shown how this connection must be made and how to merge the different component wires.

#### NOTES:

- To perform the tests you don't need to remove the automatism from its place, because this way you can understand if the automatism, directly connected to the power, can function correctly.
- A new capacitor should be used during this test to ensure that the problem is not in the capacitor.

**01** • Connect the power wires to the terminal as shown below.

**02** • Connect the automation wires to the terminal, interleaving a capacitor into the opening and closing wires.

**03** • After these connections are complete, connect to a 230V/110V power socket, depending on the motor/control board being tested.



The use of capacitors depends on the type of motor to be installed. Check in the motor manual, if it is necessary to place the capacitors, as shown in the diagram.

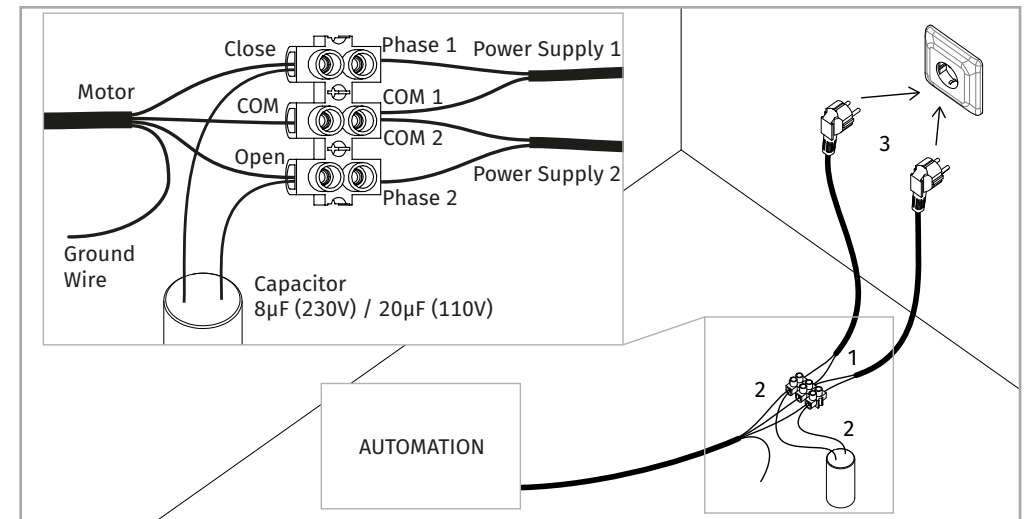

All tests must be performed by qualified personnel due to serious danger associated with the misuse of electrical systems.



# 09. TROUBLESHOOTING

## INSTRUCTIONS FOR FINAL CONSUMERS

## INSTRUCTIONS FOR TECHNICIANS

Anomaly	Procedure	Behavior	Procedure II	Discovering the origin of the problem			
• Motor doesn't work.	• Make sure you have power supply connected to control board and if it is working properly.	• Still not working.	• Consult a qualified MOTORLINE technician.	1 • Open control box and check if it has 230V power supply; 2 • Check input fuses;	3 • Disconnect motors from control board and test them by connecting directly to power supply in order to find out if they have problems (see page 11B).	4 • If the motors work, the problem is on the control board. Pull it out and send it to our MOTORLINE technical services for diagnosis;	5 • If the motors don't work, remove them from installation site and send to our MOTORLINE technical services for diagnosis.
• Motor doesn't move but makes noise.	• Unlock motor and move the gate by hand to check for mechanical problems on the movement.	• Is the gate stuck?	• Consult a qualified gates technician.	1 • Check all motion axis and associated motion systems related with the gate and automation (rails, pulleys, bolts, hinges, etc) to find out what is the problem.			
		• The gate moves easily?	• Consult a qualified MOTORLINE technician.	1 • Check capacitors, testing motor with new capacitor; 2 • If capacitors are not the problem, disconnect motors	from control board and test them by connecting directly to power supply in order to find out if they have problems (see page 11B).	3 • If the motors work, the problem is with control board. Pull it out and send it to our MOTORLINE technical services for diagnosis;	4 • If the motors don't work, remove them from installation site and send to our MOTORLINE technical services for diagnosis.
• Motors open but doesn't close.	• Unlock motor and move the gate by hand to closed position. Block the motor again and turn off power supply for 5 seconds. Reconnect it and send order to open gate using remote control.	• Gate opened but didn't close again.	1 • Check if there is any obstacle in front of the photocells; 2 • Check if any of the control devices (Key Selector, Pushbutton, Video Intercom, etc.) are stucked and sending permanent signal to control board; 3 • Consult a qualified MOTORLINE technician.	All control boards <b>MOTORLINE</b> have LEDs that easily allow to conclude which devices are with anomalies. All safety devices LEDs (Le) in normal situations remain On. All "START" circuits LEDs in normal situations remain Off. If LEDs devices are not all On, there is some security systems malfunction (photocells, safety edges). If "START" circuits LEDs are turn (Op and Cl), there is a control device sending permanent signal.		<b>A) SECURITY SYSTEMS:</b> 1 • Close with a shunt all safety systems on the control board (check manual of the control board in question). If the automated system starts working normally check for the problematic device. 2 • Remove one shunt at a time until you find the malfunction device. 3 • Replace it for a functional device and check if the motor works correctly with all the other devices. If you find another one defective, follow the same steps until you find all the problems.	<b>B) START SYSTEMS:</b> 1 • Disconnect all wires connected to the START connector. 2 • If the LED turned OFF, try reconnecting one device at a time until you find the defective device.  <b>NOTE:</b> In case procedures described in sections <b>A)</b> and <b>B)</b> don't result, remove control board and send to our <b>MOTORLINE</b> technical services for diagnosis.
• Motor doesn't make complete course.	• Unlock motor and move gate by hand to check for mechanical problems on the gate.	• Encountered problems?	• Consult an experienced gates expert.	1 • Check all motion axis and associated motion systems related with the gate and automation (rails, pulleys, bolts, hinges, etc) to find out what is the problem.			
		• The gate moves easily?	• Consult a qualified MOTORLINE technician.	1 • Check capacitors, testing with new capacitors; 2 • If capacitors are not the problem, disconnect motor from control board and test it by connecting directly to power supply in order to find out if it is broken; 3 • If the motor(s) doesn't work,	remove it from installation site and send to our MOTORLINE technical services for diagnosis. 4 • If motor work well and move gate at full force during the entire course, the problem is with control board. Set force using trimmer on the board. Make a new working time programming, giving enough time for opening and closing with	appropriate force (consult control board manual). 5 • If this doesn't work, remove control board and send it to MOTORLINE technical services.	<b>NOTE:</b> Setting force of the control board should be enough to make the gate open and close without stopping, but should stop and invert with a little effort from a person. In case of safety systems failure, the gate shall never cause physical damaged to obstacles (vehicles, people, etc.).